



# RASTAR

STOCK CODE : 300043.SZ



## RASTAR GROUP

Add: Xinghui Industrial Park, Xiadao Road, Shanghai, Chenghai, Shantou, Guangdong, China.  
Tel: +86-754-89890006 Fax: +86-754-89890001  
E-mail: toysinfo@rastar.com Http://www.rastar.com

## RASTAR (HK) INDUSTRIAL CO.,LTD.

Add: Unit 1, 5/F, Concordia Plaza, No.1 Science Museum Road, T.S.T. East, Kowloon, HongKong.  
Tel: +852-35904300 Fax: +852-35905100

## Rastar Guangzhou Office:

Add: Rastar Center, No. 122, Western Huangpu Avenue, Tianhe District, Guangzhou China  
Tel: +86-020-28123588 Fax: +86-020-28123521

## Rastar Shantou Office:

Add: FL 24-25, RongXing Building, HuangShan Road, Longhu, Shantou, Guangdong, China  
Tel: +86-754-89890006 Fax: +86-754-89890001

# RASTAR BABY

C A T A L O G

WWW.RASTAR.COM  
2022 JAN EDITION

**DECLARATION: The trademark and the design of the enclosed products are the property of original obligee, RASTAR GROUP or RASTAR (HK) INDUSTRIAL COMPANY LIMITED is licensee in obtaining permission from original obligee to produce and distribute.**



Produced under license of Ferrari S.p.A. The name FERRARI, the PRANCING HORSE device, all associated logos and distinctive designs are property of Ferrari S.p.A. The body designs of the Ferrari cars are protected as Ferrari S.p.A. property under design, trademark and trade dress regulations



The "Lamborghini" and "Lamborghini Bull and Shield" trademarks, copyrights, designs and models are used under license from Automobili Lamborghini S.p.A, Italy.



The BMW logo and the BMW wordmark are trademarks of BMW AG and are used under License.



The MINI logo and the MINI wordmark are trademarks of BMW AG and are used under License.





Porsche, the Porsche shield and the distinctive design of Porsche cars are trademarks and trade dress of Porsche AG. Permission granted.



Land Rover and the Land Rover Logo are trademarks owned and licensed by Jaguar Land Rover Limited.

## Mercedes-Benz

"Mercedes-Benz",   and the design of the enclosed product are subject to intellectual property protection owned by Daimler AG. They are used by Rastar(HK) Industrial Company Limited under license

## Audi

Trademarks, design patents and copyrights are used with the approval of the owner AUDI AG.



Manufactured under licence from Bentley Motors Limited England. "Bentley", the 'B' in wings device and other associated logos and names are trademarks of Bentley Motors Limited. The body designs of Bentley motor cars are protected by Bentley Motors Limited under design, trademark and intellectual property law.



Trademarks, design patents and copyrights are used with the approval of the owner Volkswagen Zubehör GmbH



**Rastar Group** was formed as a plastic products manufacturing firm in 2000, and become one of China's largest producers of remote-control cars, ride on cars, bike and baby products. The company obtained manufacturing and distribution licenses for more than 300 vehicles from 28 world-famous vehicle brands including Ferrari, Lamborghini, Bugatti, Bentley, Porsche, BMW, Audi, Mercedes-Benz etc. The company was listed on GEM of Shenzhen Stock Exchange in January 2010. Starting from 2013, Rastar Group entered the mobile games, sports business through a series of acquisitions. Interactive entertainment is a main line of the company development. With comprehensive layout in multi-media, multi-channel and multi-product, Rastar actively builds interactive entertainment platform of the whole industry.



Rastar Group is a leading company of Toys manufacturing and a supplier for licensed model cars of globally famous brand, offering includes Licensed RC & Die Cast & Ride On cars, bikes, patent walking suitcase, multi-functional toys.



With the development of the internet and intelligent technology, starting in 2013, Rastar entered the mobile games, video games through a series of acquisitions. Rastar Teamtop is a distinguished game development, production and operation company. In future, games will be integrated with IP of film, cartoon and novel in respect to content creation, marketing and branding.



Rastar Group set foot in Sports field from 2015, and holds a La Liga club RCD Espanyol which has a long history of more than 123 years.

### In Future

Let Health & Happiness surround you.



# Contents

## P29

Curio Multifunctional Walker & GYM 2 in 1

## P30

Rastar 3 in 1 Baby Walker



## P03 - P20

Licensed Electric Ride on

## P21 - P28

Licensed Baby Racer



## P33 - P34

Rastar Garbage Truck

## P31 - P32

Curio Multi-functional Rocking Horse 3 in 1



## P39 - P40

Rastar Water World Fishing Game

## P35 - P38

Rastar Magnetic Series



## P53 - P58

Land Rover Kids Bicycle

## P41 - P52

BMW Kids Bicycle



## P77

Package

## P75 - P76

MINI Foldable Scooter

## P59 - P74

MINI Cooper Bicycle





Produced under license of Ferrari S.p.A. The name FERRARI, the PRANCING HORSE device, all associated logos and distinctive designs are property of Ferrari S.p.A. The body designs of the Ferrari cars are protected as Ferrari S.p.A. property under design, trademark and trade dress regulations



## Ferrari 488 PISTA SPIDER

ITEM NO. : 82900

### Specifications:

Motor: 550

Battery: 1\*12V Lead-Acid rechargeable battery or 1\*11.1V Lithium rechargeable battery(optional)

Charging way: Charging independently(with battery box and portable handlebar) or Charging together with the car

Speed: 2-5km/h

Driving Time

- Lead-Acid rechargeable battery:

Around 1 hour

- Lithium rechargeable battery:

Around 1.5 hours Charging Period

- Lead-Acid rechargeable battery:

Around 8-10 hours

- Lithium rechargeable battery:

Around 2-3 hours

Maximum loading weight: 30kg

Assembly required

Assembled Dimensions: 120.2\*62.7\*52.4cm

Box Dimensions: 124\*63\*39cm

Color: Red ●

Please refer to Page 75 for package info



### Feature:

- Radio control/Battery operated Mode
- 2.4G Frequency
- Emulational steering wheel
- Intelligent instrument panel with blue tooth Control Center-Volume leveling, Playing music, Lighting Control, Connecting with Mobile phone
- Function: Forward, Reverse, Turn left, Turn right, Stop
- Motor overcurrent protection & Sleeping power saving mode
- Electric power steering system & Mechanical steering system
- Electromagnetic braking system
- LED Headlight and Taillight
- Infinitely variable speeds
- Launched with keyless-go system
- PP wheels or EVA wheels(optional)
- New style safety belt
- Five points belt makes kids safe
- Extra storage at front hood(with lock) and under-seat, kids can put toys into it
- There' s a handlebar at the back side of the car and training wheels at the front side of the car, it' s convenient for parents to bring the car back
- Easy wheel installation
- Doors can be opened by hand
- With car chassis
- Leather car seat
- Rear wheels with suspension system

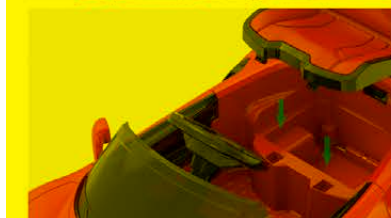



## Ferrari FXX K

ITEM NO. : 82700

### Specifications:

Motor: 550

Battery: 1x6/12 Volt Rechargeable Battery(optional)

Speed: D1 2-3km/h, D2 3-4km/h

Drive Time: 1-1.5 hours

Assembly required

Assembled Dimensions: 122\*60\*51cm

Box Dimensions: 124\*63\*38cm

Weight: 22.84/17.3kg

Color: Red ● Yellow ●

Please refer to Page 75 for package info.



### Feature:

- Radio Control / Battery Operated  
( 2 speed for battery operated mode)
- 3 Speed for Radio Control (mode optional)
- 2.4G Frequency
- Emulational steering wheel
- Drive: Forward, reverse, turn left, turn right, stop
- LED headlights & rear lights
- Kids' songs / Engine sounds IC (optional)
- Launched with keyless-go system
- With car chassis
- The doors can be opened manually
- Leather car seat
- New style safety belt, Aux input Line
- Instrument panel with lights
- Easy wheel installation
- Excellent appearance, bodywork painted by ABB spray-painting Robot
- With one set of DIY labels for car body



Produced under license of Ferrari S.p.A. The name FERRARI, the PRANCING HORSE device, all associated logos and distinctive designs are property of Ferrari S.p.A. The body designs of the Ferrari cars are protected as Ferrari S.p.A. property under design, trademark and trade dress regulations





The BMW logo and the BMW wordmark are trademarks of BMW AG and are used under License.

# BMW MOTORCYCLE S1000XR

ITEM NO. : 87700



### Feature:

- Battery Operated
- Drive: Forward, reverse, turn left, turn right, stop
- Control the speed with simulated handlebar accelerator
- LED headlights(High Beam,Low Beam) & Rear lights
- Instrument panel with lights
- With MP3 input
- With engine sound
- With pedal electronic disc brake
- Excellent appearance,bodywork painted by ABB spray-painting Robot

### Specifications:

- Motor:550
- Battery:1x6/12 Volt Rechargeable Battery(optional)
- Assembled Dimensions:102x31x57cm
- Box Dimensions:104.5x32.5x58cm
- Weight:14.6/11.9kg
- Color:Red ● White ○
- Please refer to Page 75 for package info.



- Item No.: RATHMT02MB
- Product Name: RASTAR Helmet
- Box Dimensions: 26x22x17cm
- Color:Black ●



RASTAR GROUP

# Lamborghini Urus Concept

ITEM NO. : 82600



### Feature:

- Radio Control/Battery Operated (2 speed for battery operated mode)
- 3 speed for Radio Control(mode optional)
- 2.4G Frequency
- Emulational steering wheel
- Drive: Forward, reverse, turn left, turn right, stop
- LED headlights & rear lights
- Kids' songs/Engine sounds IC(optional)
- Launched with keyless-go system
- With car chassis
- Leather Car Seat
- Easy wheel installation
- Excellent appearance, bodywork painted by ABB spray-painting Robot

### Specifications:

- Motor: 550
- Battery: 1x6/12 Volt Rechargeable Battery(optional)
- Speed: D<sub>1</sub> 2-3km/h, D<sub>2</sub> 3-4km/h
- Drive Time: 1-1.5 hours
- Assembly required
- Assembled Dimensions: 122.2\*63.7\*44.1cm
- Box Dimensions: 127\*60\*40cm
- Weight: 21.3/16.8kg
- Color: Red ● Yellow ●
- Please refer to Page 75 for package info.



RASTAR GROUP

The "Lamborghini" and "Lamborghini Bull and Shield" trademarks, copyrights, designs and models are used under license from Automobili Lamborghini S.p.A, Italy.



# Audi TTS Roadster

ITEM NO. : 82500

## Feature:

- Radio Control/Battery Operated  
(2 speed for battery operated mode)
- 3 speed for Radio Control(mode optional)
- 2.4G Frequency
- Emulational steering wheel
- Drive: Forward, reverse, turn left, turn right, stop
- LED headlights & rear lights
- Kids' songs/Engine sounds IC(optional)
- Launched with keyless-go system
- With car chassis
- Easy wheel installation
- Excellent appearance, bodywork painted by ABB spray-painting Robot



## Specifications:

- Motor: 550
- Battery: 1x6/12 Volt Rechargeable Battery(optional)
- Speed: D<sub>1</sub> 2-3km/h, D<sub>2</sub> 3-4km/h
- Drive Time: 1-1.5 hours
- Assembly required
- Assembled Dimensions: 121.1\*65.5\*48cm
- Box Dimensions: 127\*63\*38cm
- Weight: 19.06/15.04kg
- Color: Red ● Yellow ● White ○
- Please refer to Page 75 for package info.



RASTAR GROUP

Trademarks, design patents and copyrights are used with the approval of the owner AUDI AG.







Manufactured under licence from Bentley Motors Limited England. "Bentley", the 'B' in wings device and other associated logos and names are trademarks of Bentley Motors Limited. The body designs of Bentley motor cars are protected by Bentley Motors Limited under design, trademark and intellectual property law.

## Bentley Continental GT Speed Convertible

ITEM NO. : 82100



### Feature:

- Radio Control/Battery Operated  
(2 speed for battery operated mode)
- Drive: Forward, reverse, turn left, turn right, stop
- LED headlights & rear lights
- Kids' song /Engine sounds IC(optional)
- Emulational steering wheel & key
- With car chassis
- Excellent appearance, bodywork painted by ABB spray-painting Robot

### Specifications:

- Motor: 550
- Battery: 1x6/12 Volt Rechargeable Battery(optional)
- Speed: D<sub>1</sub> 2-3km/h, D<sub>2</sub> 3-4km/h
- Drive Time: 1-1.5 hours
- Assembly required
- Assembled Dimensions: 120\*66\*47.4cm
- Box Dimensions: 123.5\*58\*38cm
- Weight: 15.9/12.7kg
- Color: White ○ Orange ● Black ●
- Please refer to Page 75 for package info.



RASTAR GROUP



Land Rover and the Land Rover Logo are trademarks owned and licensed by Jaguar Land Rover Limited.

## Range Rover Evoque

ITEM NO. : 81400

### Feature:

- Radio Control/Battery Operated  
(2 speed for battery operated mode)
- Drive:Forward, reverse, turn left, turn right, stop
- LED headlights & rear lights, MP3 input
- Kids' songs/Engine sounds IC(optional)
- Emulational steering wheel & key
- With car chassis
- Excellent appearance, bodywork painted by ABB spray-painting Robot

### Specifications:

- Motor: 550
- Battery:1x6/12 Volt Rechargeable Battery(optional)
- Speed: D<sub>1</sub> 2-3km/h,D<sub>2</sub> 3-4km/h
- Drive Time: 1-1.5 hours
- Assembly required
- Assembled Dimensions:120\*64.7\*51.6cm
- Box Dimensions:127\*57\*37cm
- Weight:17.9/14.8kg
- Color:White ○ Red ● Black ●
- Please refer to Page 75 for package info.

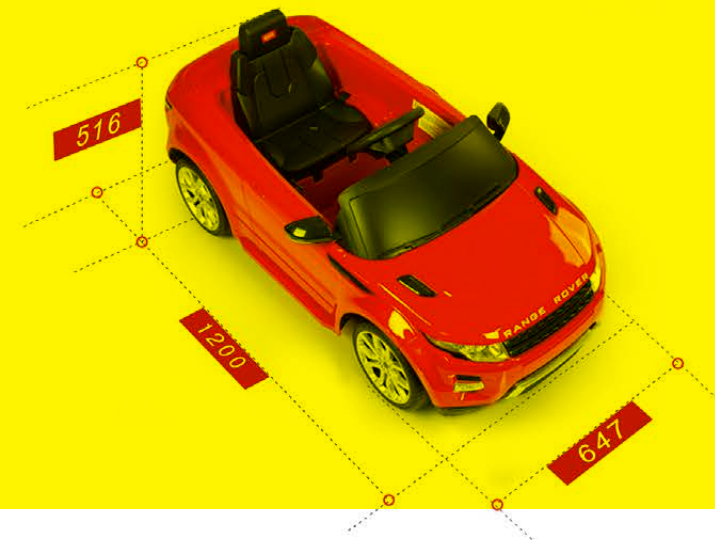

# Lamborghini Aventador LP700-4

ITEM NO. : 81700



## Feature:

- Radio Control/Battery Operated
- Drive: Forward, reverse, turn left, turn right, stop
- LED headlights, MP3 input
- Kids' songs/Engine sounds IC(optional)
- Emulational steering wheel & key
- Excellent appearance, bodywork painted by ABB spray-painting Robot

## Specifications:

- Motor: 550
- Battery: 1x6Volt Rechargeable Battery
- Speed: 3-4km/h
- Drive Time: 1-1.5 hours
- Assembly required
- Assembled Dimensions: 112.2x63.5x43cm
- Box Dimensions: 115.5\*58\*35.5cm
- Weight: 14.8/11.7kg
- Color: Orange ● Yellow ○ White ○
- Please refer to Page 75 for package info.



RASTAR GROUP

The "Lamborghini" and "Lamborghini Bull and Shield" trademarks, copyrights, designs and models are used under license from Automobili Lamborghini S.p.A, Italy.



## Mercedes-Benz SLK

ITEM NO. : 81200

### Feature:



- Radio Control/Battery Operated
- Drive: Forward, reverse, turn left, turn right
- LED headlights,MP3 input
- Kids' songs/Engine sounds IC(optional)
- Emulational steering wheel & key
- Excellent appearance, bodywork painted by ABB spray-painting Robot

### Specifications:

- Motor: 550
- Battery:1x6Volt Rechargeable Battery
- Speed:3-4km/h
- Drive Time: 1-1.5 hours
- Assembly required
- Assembled Dimensions:110x57.8x49cm
- Box Dimensions:112.5x54.5x34cm
- Weight:15.3/12.6kg
- Color:Red ● White ○ Black ●
- Please refer to Page 75 for package info.



RASTAR GROUP

"Mercedes-Benz",   and the design of the enclosed product are subject to intellectual property protection owned by Daimler AG.They are used by Rastar(HK) Industrial Company Limited under license



**MERCEDES-BENZ**  
Mercedes-Benz SLK 55 AMG

**PORSCHE**  
911 Turbo S

**PORSCHE**  
OFFICIAL LICENSED PRODUCT

**FERRARI**  
488 GTE



**LAMBORGHINI**  
Lamborghini Urus Concept



**VOLKSWAGEN**  
Volkswagen Beetle



Volkswagen  
Official Licensed Product



RASTAR GROUP



## Lamborghini Urus Concept Foot to Floor



The trademarks, copyrights and design rights in and associated with Lamborghini, Lamborghini with Bull and Shield Device and the following Lamborghini vehicle Urus Concept are used under license from Automobili Lamborghini S.p.A., Italy



ITEM NO.	PRODUCT(cm)	CARTON SIZE(cm)	PCS/CTN	WEIGHT (kg)	COLOR
83600	70x30.3x39.7	71.5x31x29	1	3.8/2.7	Yellow ● Red ●

### FEATURE:

This RASTAR Foot to Floor offers imaginative fun for younger kids' learning and playing, intently watch the development of their leg and ankle.  
With emulational steering wheel design and horn.  
With leather material for carseat.



## 488 GTE Foot to Floor



Produced under license of Ferrari S.p.A. The name FERRARI, the PRANCING HORSE device, all associated logos and distinctive designs are property of Ferrari S.p.A. The body designs of the Ferrari cars are protected as Ferrari S.p.A. property under design, trademark and trade dress regulations



ITEM NO.	PRODUCT(cm)	CARTON SIZE(cm)	PCS/CTN	WEIGHT (kg)	COLOR
83500	69.9x30.2x38.2	71.5x31x29	1	3.8/2.7	Yellow ● Red ●

### FEATURE:

This RASTAR Foot to Floor offers imaginative fun for younger kids' learning and playing, intently watch the development of their leg and ankle.  
With emulational steering wheel design and horn.  
With leather material for carseat.  
With two sets of DIY label.

PORSCHE

OFFICIAL LICENSED PRODUCT

## Porsche 911 Turbo S Foot to Floor



Porsche, the Porsche shield and the distinctive design of Porsche cars are trademarks and trade dress of Porsche AG. Permission granted.



ITEM NO.	PRODUCT(cm)	CARTON SIZE(cm)	PCS/CTN	WEIGHT (kg)	COLOR
83400	69.7x30.2x38	71.5x31x29	1	3.8/2.7	Yellow ● Red ● White ○

**FEATURE:** This RASTAR Foot to Floor offers imaginative fun for younger kids' learning and playing, intently watch the development of their leg and ankle. With emulational steering wheel design and horn.

## Mercedes-Benz SLK 55 AMG Foot to Floor



"Mercedes-Benz",  and the design of the enclosed product are subject to intellectual property protection owned by Daimler AG. They are used by Rastar(HK) Industrial Company Limited under license



ITEM NO.	PRODUCT(cm)	CARTON SIZE(cm)	PCS/CTN	WEIGHT (kg)	COLOR
82300	69x30.2x38	71.5x31x29	1	3.8/2.7	Yellow ● Red ● White ○

**FEATURE:** This RASTAR Foot to Floor offers imaginative fun for younger kids' learning and playing, intently watch the development of their leg and ankle. With emulational steering wheel design and horn.



## Volkswagen The Beetle Foot to Floor

Steering wheel with sound & lights



Trademarks, design patents and copyrights are used with the approval of the owner Volkswagen Zubehör GmbH



ITEM NO.	PRODUCT(cm)	CARTON SIZE(cm)	PCS/CTN	WEIGHT(kg)	COLOR
85700(With sounds & light)	65.7x30.2x38	71.5x31x29	1	3.8/2.7	Yellow ● Pink ●
85710(Without sounds & light)					Red ●

This RASTAR Foot to Floor offers imaginative fun for younger kids' learning and playing, intently watch the development of their leg and ankle.

**FEATURE:** With emulational steering wheel design and horn.  
Steering wheel with sound & lights(Optional).  
With two sets of DIY labels.

## GOGO BIKE



ITEM NO.	85200
PRODUCT SIZE (cm)	66.4x31.3x44.1
CARTON SIZE (cm)	59.5x32x44.5
PCS/CTN	2
WEIGHT(kg)	5.9/5.0
COLOR	● Yellow ● Orange

**● FEATURE**  
This RASTAR GOGO Bike offers imaginative fun for younger kids' learning and playing, With great shape design.



## RASTAR 3 IN 1 BABY WALKER



## CURIO MULTIFUNCTIONAL WALKER & GYM 2 IN 1



RASTAR GROUP



Item No.:	89300
Product Size(cm):	35*38*42
Package Size(cm):	62*14*34
Carton QTY:	4
N.W.	3.2KG
Color	Red,Blue,Yellow

**Feature:**  
 -Baby Walker Mode,Education Mode,Table Mode  
 -With Emulational Steering Wheel design & Horn  
 -With Music & Engine Sound  
 -With Easy-grasp handle  
 -Function:Pressing the button,the learning walker will have the music and sounds;turn the steering wheel,it will have the engine sound and horn;the baby walker will be in sleeping mode if there's no action in 1 mintue,and press key to wake it up.



Item No.:	SXC1801
Description:	MULTIFUNCTIONAL WALKER & GYM 2 IN 1
Carton Size(cm):	52.5*37.5*41.5
Package Size(cm):	51*12*19
Product Size(cm):	50.6*43.6*42.8
Carton QTY:	6
CU.M/CU.FT:	0.082/2.9
Color:	Blue/Pink

**Feature:**  
 -Age for 3 Months +;  
 -Accessories list: A. Bracket Component 2pcs  
 B. Handle Bar 1pcs  
 C. Cross Bar 1pcs  
 D. Bell/Spinning Mirror/Butterfly 3pcs  
 -Features: A. Gym Mode A (3-6 Months)  
 B. Gym Mode B (7 Months +)  
 C. Walker Mode (12 Months +)  
 -Speed Adjustment,Foldable  
 -Material:ABS

## CURIO MULTI-FUNCTIONAL ROCKING HORSE 3IN1



Item No.:	SXC1802	Feature:
Description:	Multi-functional Rocking Horse 3in1	1, Age for 1-5 years old;
Carton Size(cm):	60*37*28	2, Features:
Product Size(cm):	58.3*35.6*37.3	A. Rocking Horse Mode (12 Months+)
Carton QTY:	1	B. Dragging Mode (18 Months+)
CU.M/CU.FT:	0.062/2.19	C. Slide Bike Mode (24 Months+)
Color:	Blue/Red	3, Tool for baby's physical exercise,inspiring baby to explore in playing;
		4, The String is excluded.

## MICRO BALANCE BIKE



Item No.:	SCX1901	Feature:
Description:	Micro Balance Bike	1, Age for 18-48 months;
Carton Size(cm):	52*22*27	2, Features:
Product Size(cm):	46*24*38	A. Upgraded four-wheeled design with safety;
Carton QTY:	1	B. Sliding for assisting walking, exercising baby's balance;
CU.M/CU.FT:	0.031/1.09	C. EVA high-density wide tires,which is skid resistant and denoised;
Color:	Pink/Blue/Yellow	C. 135° limit steering, which is safe and without rollover;
		3, Material: Carbon Steel & EVA.

## RASTAR GARBAGE TRUCK



Item No.:	63700
Product Size(cm):	35.5*16*19.5
Package Size(cm):	40*21.5*29.5
Carton QTY:	4
CU.M/CU.FT:	0.114/4.03
Color:	Blue,Red, Yellow

- Feature:
- With Led Light,Music
  - Forward,Reverse,Turn left,Turn right by hand
  - Clean up automatically
  - With Front Sweeping wheels,Roller,Trunk
  - Demo Function
  - For age 3-6 years old

# CONSTRUCTION VEHICLES



## MAGNETIC SERIES

### Excavator

Item No.: 77810  
 Colour: Yellow  
 Product Size: 18\*5.7\*9cm  
 Package Size: 24.5\*14\*10cm  
 Carton Size: 50.5\*43.5\*43.5cm  
 CU./M/CU.FT: 0.093/3.28  
 Features: Friction



### Ladder truck

Item No.: 77820  
 Colour: Red  
 Product Size: 14.6\*5.7\*9.5cm  
 Package Size: 24.5\*14.5\*10cm  
 Carton Size: 50.5\*43.5\*43.5cm  
 CU./M/CU.FT: 0.093/3.28  
 Features: Friction



### Concrete mixer

Item No.: 77830  
 Colour: Red  
 Product Size: 17.6\*5.7\*10.5cm  
 Package Size: 24.5\*14\*10cm  
 Carton Size: 50.5\*43.5\*43.5cm  
 CU./M/CU.FT: 0.093/3.28  
 Features: Friction



### Logging Truck

Item No.: 77840  
 Colour: Blue  
 Product Size: 24\*5.7\*6.7cm  
 Package Size: 24.5\*14\*10cm  
 Carton Size: 55.5\*50.5\*43.5cm  
 CU./M/CU.FT: 0.11/3.86  
 Features: Pull back

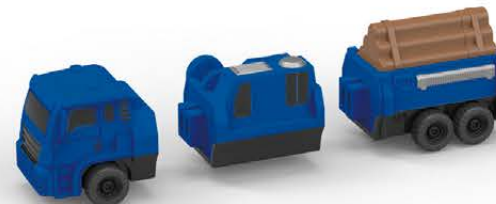

### Road Roller

Item No.: 77850  
 Colour: Yellow  
 Product Size: 17.5\*5.7\*7.7cm  
 Package Size: 24.5\*14\*10cm  
 Carton Size: 50.5\*43.5\*43.5cm  
 CU./M/CU.FT: 0.093/3.28  
 Features: Pull back



### Transport Aircraft

Item No.: 77860  
 Colour: Blue  
 Product Size: 21.3\*18.3\*5.8cm  
 Package Size: 24.5\*14\*13cm  
 Carton Size: 55.5\*50.5\*43.5cm  
 CU./M/CU.FT: 0.13/4.59  
 Features: Pull back

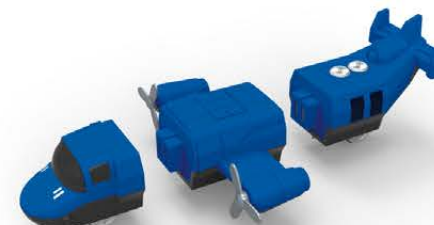

# MAGNETIC SERIES

Item No.: 77800	Item No.: 77800-5	Item No.: 77800-4	Item No.: 77800-3
Colour: Blue/Yellow/Red	Colour: Blue/Yellow/Red	Colour: Blue/Yellow/Red	Colour: Blue/Yellow/Red
Package Size: 66*40*8.8cm	Package Size: 51.5*40*9cm	Package Size: 45.8*39.5*9cm	Package Size: 44*37*9cm
Carton Size: 68*38.5*42cm	Carton Size: 56.5*52.5*42cm	Carton Size: 56*47.5*41.5cm	Carton Size: 56*45.5*38.5cm
CU.M/CU.FT: 0.12/4.24	CU.M/CU.FT: 0.125/4.4	CU.M/CU.FT: 0.092/3.25	CU.M/CU.FT: 0.098/3.46

- Features:
- Intelligence Building Block
  - Pull back, Friction
  - Material: HIPS
  - 6 in 1 & 5 in 1 & 4 in 1 & 3 in 1 & single package(Optional)

Item No.: 77800

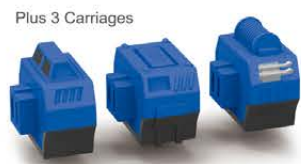
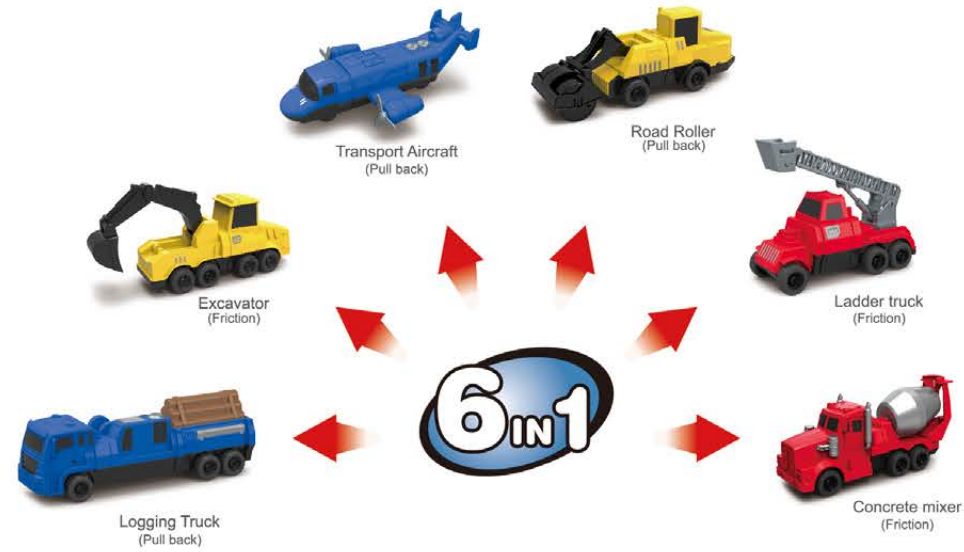

Item No.: 77800-5

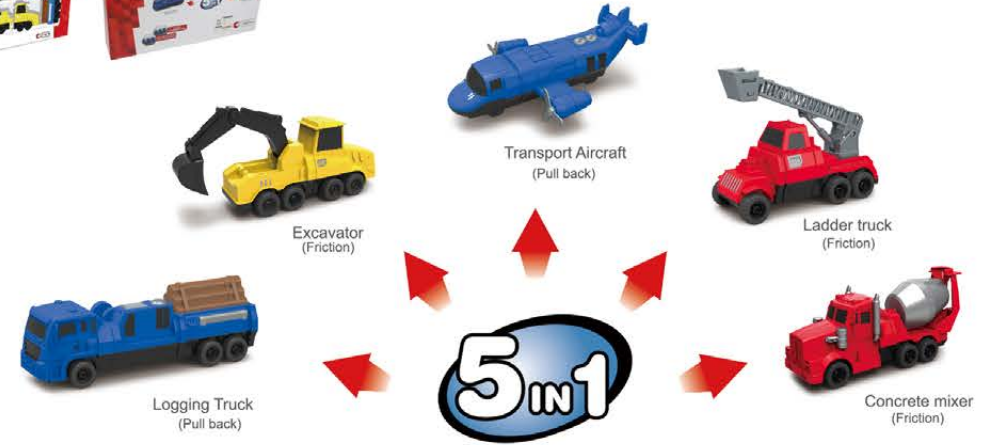

Item No.: 77800-4

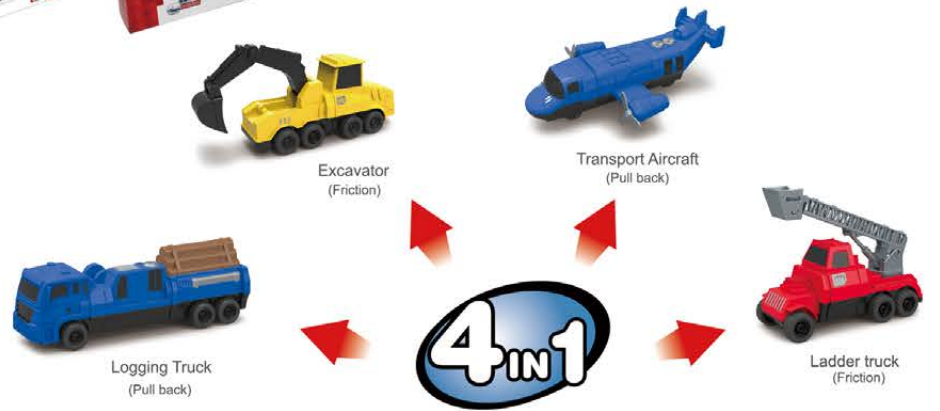

Item No.: 77800-3

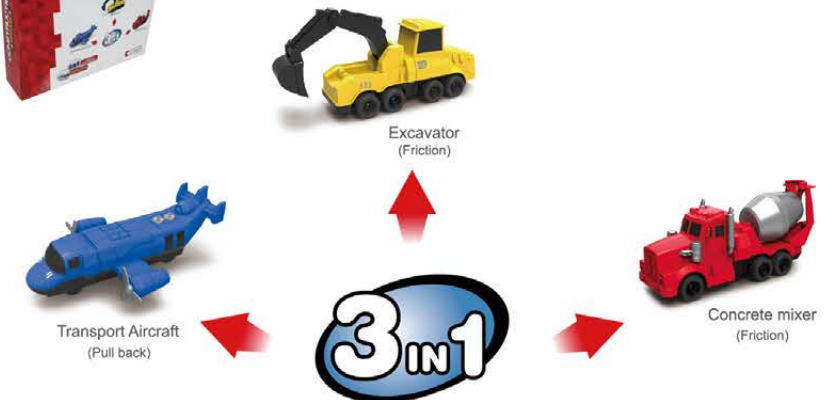

# Rastar Water World Fishing Game

ITEM NO. : 87800

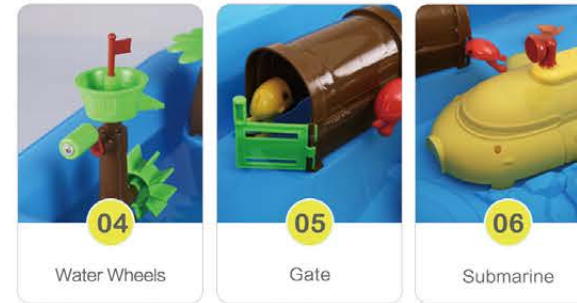
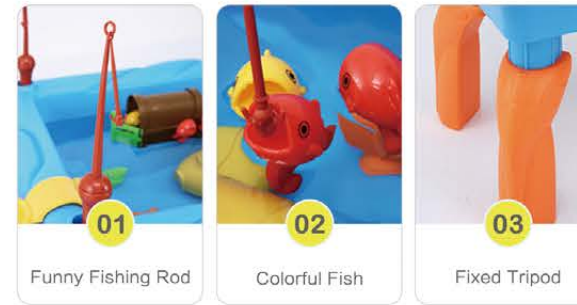

**Feature:**

- Running Water(Controlled by Motor or Manual)
- The fishes will swim with running water
- With LED light & Music & Sound of Water
- Fishing

**Specifications:**

Spare parts:6 fishes & 2 fishing rods

Product Dimensions:60\*45\*40cm

Box Dimensions:46.5\*38.5\*63cm

N.W./G.W.: 4.9KG/7.4KG

Color:Yellow ● Blue ●

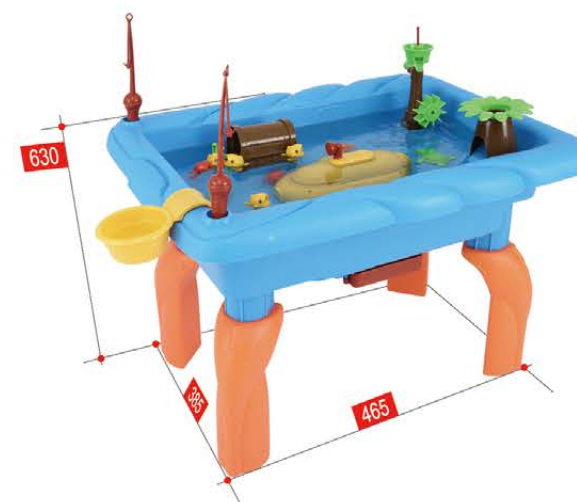

RASTAR GROUP



**BMW Official  
Licensed Product**



The BMW logo and the BMW wordmark are trademarks of BMW AG and are used under License.

## BMW TRICYCLE 10"

ITEM NO.	RSZ3006
Product Size (mm)	710*493*527
Carton Size (mm)	550*270*390
Main material	Carbon steel
For age	2-5 Years old
Maximum Loading Weight(kg)	30
N.W./G.W.(kg)	4.39 / 5.62
Color	White, Blue, Red, Grey



RASTAR GROUP



**BMW Official  
Licensed Product**



## BMW FOLDABLE TRICYCLE 10"

ITEM NO.	RSZ3007
Product Size (mm)	688*490*570
Carton Size (mm)	620*520*450
Main material	Carbon steel
For age	2-5 Years old
Maximum Loading Weight(kg)	30
N.W./G.W.(kg)	7 / 10
Color	Blue



Sunshade & Rail & need to be purchased separately.

The BMW logo and the BMW wordmark are trademarks of BMW AG and are used under License.





**BMW Official  
Licensed Product**



## BMW BALANCE BIKE 12"

ITEM NO.	RSZ1206
Product Size (mm)	875*400*530
Carton Size (mm)	890*140*550
Main material	Carbon steel
For age	1.5-5 Years old
Maximum Loading Weight(kg)	45
N.W./G.W.(kg)	4.98 / 6.31
Color	Grey, Blue, Red, White



The BMW logo and the BMW wordmark are trademarks of BMW AG and are used under License.



**BMW Official  
Licensed Product**



## BMW BALANCE BIKE 12" ALUMINIUM

ITEM NO.	RSZ1208
Product Size (mm)	883*434*542
Carton Size (mm)	890*140*550
Main material	Aluminium
For age	2-5 Years old
Maximum Loading Weight(kg)	45
N.W./G.W.(kg)	4.58 / 6.90
Color	Red, Grey, Blue



RASTAR GROUP

The BMW logo and the BMW wordmark are trademarks of BMW AG and are used under License.



**BMW Official  
Licensed Product**



## BMW KIDS BIKE 14"

ITEM NO.	RSZ1405
Product Size (mm)	976*442*613
Carton Size (mm)	990*200*530
Main material	Carbon steel
For age	4-8 Years old
Maximum Loading Weight(kg)	45
N.W./G.W.(kg)	9.56 / 11.4
Color	Grey, Blue, Red, White





**BMW Official  
Licensed Product**

**BMW M.**  **M**



## BMW BIKE 18" ALUMINIUM

ITEM NO.	RSZ1801
Product Size (mm)	1285*563*786
Carton Size (mm)	1220*175*690
Main material	Aluminium
For age	5-10 years old
N.W./G.W.(kg)	10.7 / 15.7
Color	Grey, Red, Blue



RASTAR GROUP

The BMW logo and the BMW wordmark are trademarks of BMW AG and are used under License.



Land Rover and the Land Rover Logo are trademarks owned and licensed by Jaguar Land Rover Limited.



## LAND ROVER 2 IN 1 BALANCE BIKE & TRICYCLE FOLDABLE

ITEM NO.	RSZ3005
Product Size (mm)	694*450*537
Carton Size (mm)	450*270*360
Main material	Carbon steel
For age	1.5-5 Years old
Maximum Loading Weight(kg)	30
N.W./G.W.(kg)	4.85 / 5.54
Color	Grey,Blue,Red





Land Rover and the Land Rover Logo are trademarks owned and licensed by Jaguar Land Rover Limited.

## LAND ROVER TRICYCLE 10"

ITEM NO.	RSZ3004
Product Size (mm)	690*515*535
Carton Size (mm)	550*270*390
Main material	Carbon steel
For age	2-5 Years old
Maximum Loading Weight(kg)	30
N.W./G.W.(kg)	4.39 / 5.62
Color	White, Blue, Red, Black



Land Rover and the Land Rover Logo are trademarks owned and licensed by Jaguar Land Rover Limited.

## LAND ROVER BALANCE BIKE 12"

ITEM NO.	RSZ1205
Product Size (mm)	865*305*500
Carton Size (mm)	770*190*395
Main material	Carbon steel
For age	1.5-5 Years old
Maximum Loading Weight(kg)	45
N.W./G.W.(kg)	5.60 / 6.83
Color	Silver, Blue, Red





Land Rover and the Land Rover Logo are trademarks owned and licensed by Jaguar Land Rover Limited.

### LAND ROVERDISCOVERY KIDS BIKE 14"

ITEM NO.	RSZ1406
Product Size (mm)	960*415*580
Carton Size (mm)	990*180*540
Main material	Carbon steel
For age	4-8 Years old
Maximum Loading Weight(kg)	45
N.W./G.W.(kg)	10 / 11.6
Color	Blue, Red, Yellow



Land Rover and the Land Rover Logo are trademarks owned and licensed by Jaguar Land Rover Limited.

### LAND ROVER KIDS BIKE 16"

ITEM NO.	RSZ1606
Product Size (mm)	1098*430*630
Carton Size (mm)	1100*205*610
Main material	Carbon steel
For age	4-8 Years old
Maximum Loading Weight(kg)	45
N.W./G.W.(kg)	10.36 / 12.4
Color	Silver, Blue, Red



# MINI



# MINI HELMET

## MINI FOLDABLE TRICYCLE 10"

ITEM NO.	RSZ3003
Product Size (mm)	700*430*956
Carton Size (mm)	460*420*680
Main material	ABS / PP / Iron
For age	1-4 Years old
N.W./G.W.(kg)	6.5 / 9.2
Color	Chili Red, Midnight Black

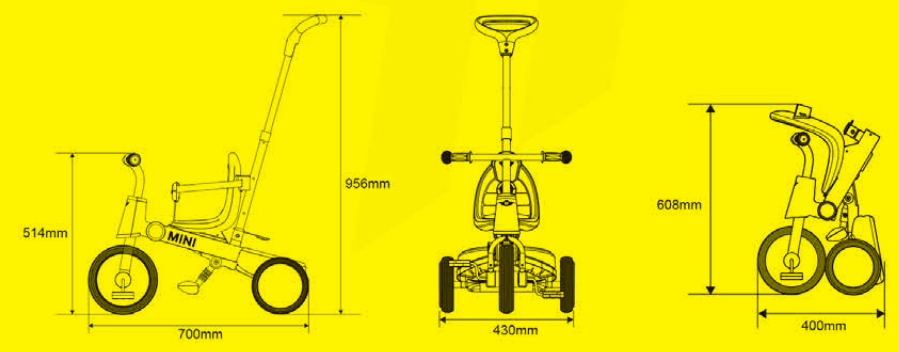

RASTAR GROUP





## MINI TRICYCLE 10"

ITEM NO.	RSZ3002
Product Size (mm)	703*515*523
Carton Size (mm)	580*270*390
Main material	Carbon steel
For age	2-5 Years old
N.W./G.W.(kg)	4.5 / 6.2
Color	Laser Blue, Chili Red

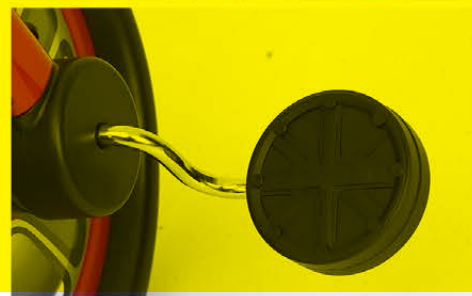
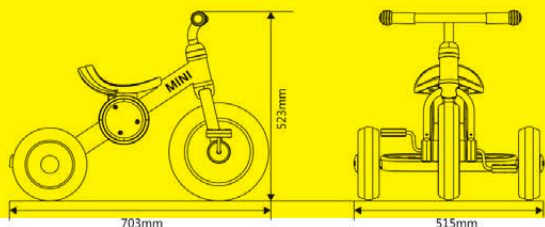

## MINI BALANCE BIKE 12" ALUMINIUM

ITEM NO.	RSZ1207
Product Size (mm)	873*393*554
Carton Size (mm)	780*190*380
Main material	Aluminium
For age	2-5 Years old
Maximum Loading Weight(kg)	45
N.W./G.W.(kg)	4.60 / 6.15
Color	Black, Red, Blue

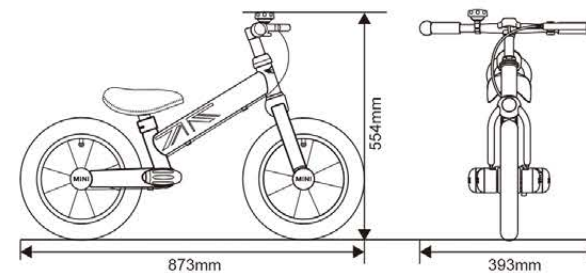



## MINI KIDS STROLLER BIKE 12"

ITEM NO.	RSZ1203
Product Size (mm)	945*390*980
Carton Size (mm)	970*205*540
Main material	Carbon steel
For age	4-6 Years old
N.W./G.W.(kg)	11 / 13.3
Color	Lightning Blue, Chili Red,

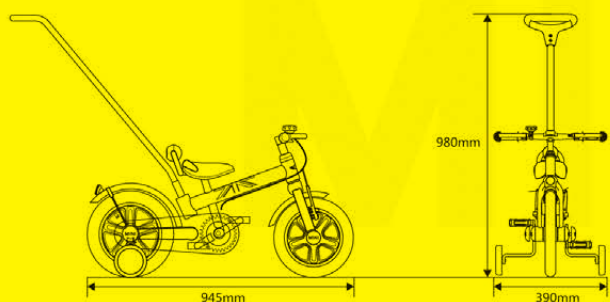

## MINI FIRST BIKE 12"

ITEM NO.	RSZ1204
Product Size (mm)	860*390*530
Carton Size (mm)	750*205*360
Main material	Carbon steel
For age	3-5 Years old
N.W./G.W.(kg)	5.95 / 7.35
Color	Lightning Blue, Chili Red, Midnight Black

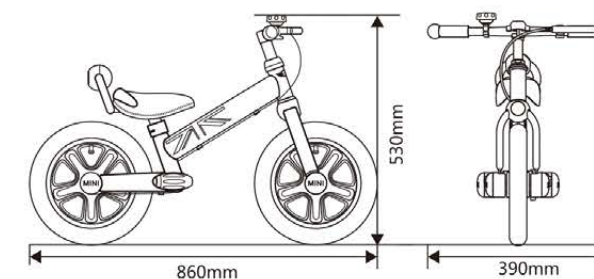



## MINI KIDS BIKE 14"

ITEM NO.	RSZ1402
L/W/H (mm)	960*415*580
Product Size (mm)	1020*205*580
Main material	Carbon steel
For age	4-6 Years old
N.W./G.W.(kg)	10.5 / 13.5
Color	White Silver, Lightning Blue, Midnight Black, Chili Red

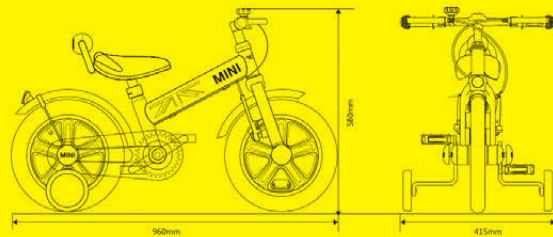

## MINI KIDS BIKE 14"

ITEM NO.	RSZ1403
Product Size (mm)	980*410*710
Carton Size (mm)	990*205*640
Main material	Carbon steel
For age	4-6 Years old
N.W./G.W.(kg)	10.9 / 13.3
Color	Chili Red, Classic Green

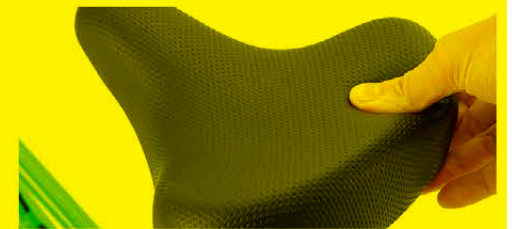



## MINI KIDS BIKE 16"

ITEM NO.	RSZ1602
Product Size (mm)	1098*430*630
Carton Size (mm)	1090*205*600
Main material	Carbon steel
For age	4-8 Years old
N.W./G.W.(kg)	10.9 / 13.8
Color	Spice Orange, Laser Blue

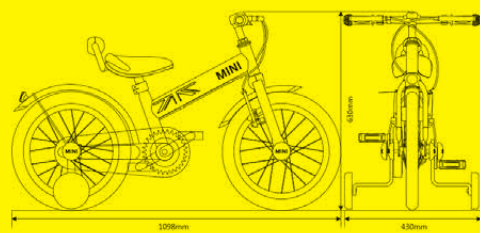

## MINI KIDS BIKE 16"

ITEM NO.	RSZ1605
Product Size (mm)	1120*410*700
Carton Size (mm)	1140*205*730
Main material	Carbon steel
For age	4-8 Years old
N.W./G.W.(kg)	12.3 / 15.8
Color	Lightning Blue, Chili Red





## MINI VELO BIKE 16"

ITEM NO.	RSZ1603
Product Size (mm)	1250*900*580
Carton Size (mm)	1250*170*680
Main material	Carbon steel
For age	8 Years old
N.W./G.W.(kg)	11 / 14.1
Color	Chili Red, Pepper White, Midnight Black



## MINI BIKE 20" ALUMINIUM

ITEM NO.	RSZ2001
Product Size (mm)	1384*577*874
Carton Size (mm)	1140*210*615
Main material	Aluminium
For age	8-13 years old
N.W./G.W.(kg)	11.3 / 14
Color	Orange, Ice Blue, Laser Blue



## MINI Helmet

Item No.: RSZHMT01  
 L/W/H (mm) 260 / 220 / 170  
 Head Circumference(mm) 490-540  
 For age Above 3 Years  
 N.W.(kg) 0.435  
 Color Chili Red, White Silver  
 Lightning Blue, Pink



## BMW Helmet

Item No.: RSZHMT02  
 L/W/H (mm) 260 / 220 / 170  
 Head circumference (mm) 530-560  
 For age Above 3 Years  
 N.W.(kg) 0.27  
 Color Red/Blue



## Accessories

### Sunshade & Rail



ITEM NO. RSZCL02  
 Suitable for MINI Fold Tricycle  
 Color Red, Blue

### Sunshade & Rail & Cushion



ITEM NO. RSZGBRO01  
 Suitable for BMW Foldable Tricycle  
 Color Blue Red

### MINI Bell



L/W/H (mm) 44 / 44 / 60  
 Suitable for Bicycle handlebar with a diameter  
 between 19.1mm and 22.2mm  
 Color Black

### Cable Lock

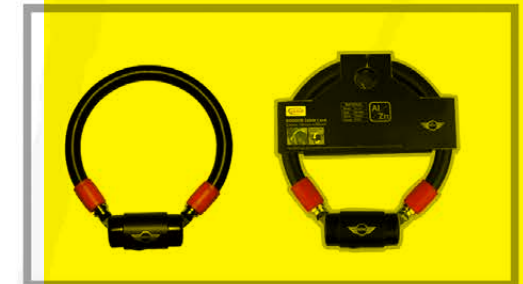

L/W (mm) 350 / 15  
 Suitable for MINI 12"/14"/16" Bike  
 Color Midnight Black

### Cable Lock



L/W (mm) 1200 / 5  
 Suitable for MINI 12"/14"/16" Bike  
 Color Chili Red



## MINI SCOOTER - STREET RIDER

Item No.: 83700  
 Product Size: 59.6\*28.1\*80cm  
 PCS/CTN: 1  
 Carton Size: 64\*17.5\*30cm  
 Color: Blue

### Features:

- Recommended age: 3+
- The adjustable handlebars have four different heights: 68cm; 72cm; 78cm; 84cm.
- Tyre is motional light up
- With 3 wheels and the rear wheel with brake
- Max loading weight: 50kg
- Material: PP & Aluminum alloy
- Foldable

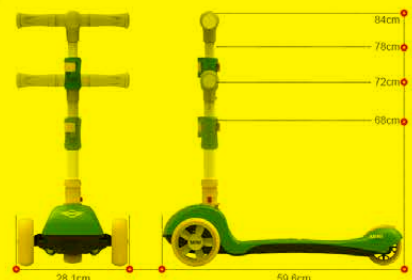

## MINI SCOOTER - PALADIN

Item No.: 83800  
 Product Size: 54.6\*28.1\*77cm  
 PCS/CTN: 1  
 Carton Size: 60.5\*16\*30cm  
 Color: Red

### Features:

- Recommended age: 3+
- The adjustable handlebars have four different heights: 59cm; 65cm; 71cm; 77cm.
- Tyre is motional light up
- With 3 wheels and the rear wheel with brake
- Max loading weight: 50kg
- Material: PP & Aluminum alloy
- Foldable

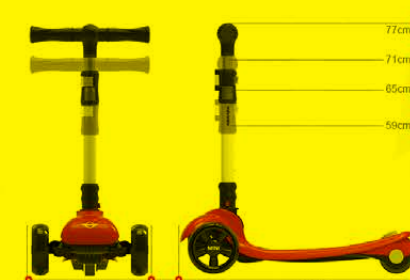

LICENSED RIDE ON  
**PACKAGE**



LICENSED BABY RACER  
**PACKAGE**



MINI SCOOTER  
**PACKAGE**



LAND ROVER KIDS BICYCLE  
**PACKAGE**

Notes:

DECLARATION:  
The trademark and the design of the enclosed products are the property of original obligee.  
RASTAR GROUP or RASTAR (HK) INDUSTRIAL COMPANY LIMITED is licensee in obtaining  
permission from original obligee to produce and distribute.